

HOOK SWITCHES

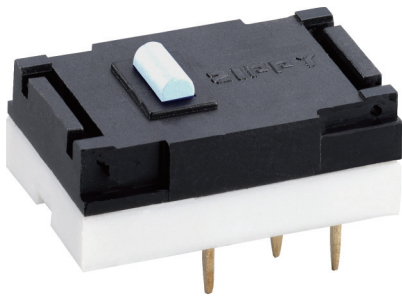

HM2 SERIES

SPECIFICATIONS

Contact Resistance(Initial)

Max. 100mΩ

Measured by ohm meter -open voltage<1VDC, driver current -100mA

Insulation Resistance (at 500 VDC / minute)

Min. 100 MΩ

Dielectric Strength

Min. 1000VAC(50-60HZ)/minute between Live parts.

Min. 1250VAC(50-60HZ)/minute between Live parts and dead metal parts

Operating Temperature Range

0°C to 65°C

Vibration

10~55Hz, displacement 0.75 mm (p-p)

Electrical Service Life

1A - Min. 6,000 operations

Other ratings - Min. 500,000 operations

Electrical Operating Frequency

10~30 operations per minute

Mechanical Service Life

Min.1,000,000 operations

Mechanical Operating Frequency

120 operations per minute

Operating application of the switch

Set the switch pushing distance from 60% to 90% of the specified OT value

RATING :

0.1A 60VDC, 0.2A 60VDC

0.2A 125 VAC, 1A 125VAC

APPLICATIONS

Telephone, Magnetic card reader

DIMENSIONS

Unless otherwise specified, a tolerance of ±0.4mm applies to all dimensions.

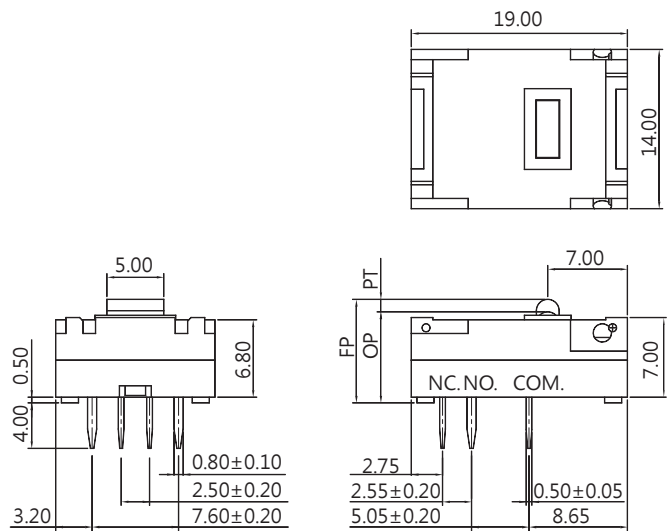

CONTACT CONFIGURATION

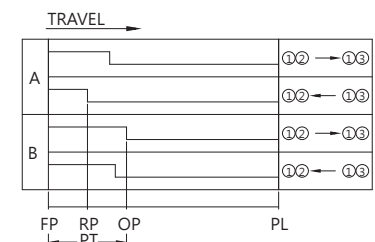
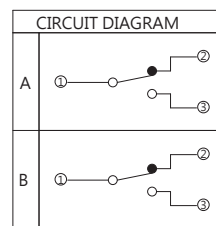

MOUNTING HOLES

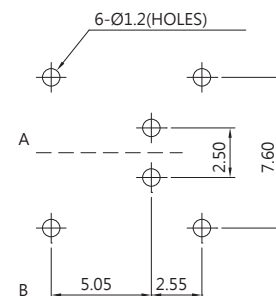





THE SELECTION OF RATING & FORCE

MODEL	Rating	L	S	H
HM2	0.1A	*	*	*
	0.2A	*	*	*
	1A		*	*

NOTE : The Symbol " * " to represent the result is accepted

ORDERING INFORMATION

H M 2	0 1	S	0 0	0	Z
SERIES PREFIX	CODE RATING CURRENT	CODE OPERATING FORCE	CODE ACTUATOR TYPE	CODE CIRCUIT ARRANGEMENT	ROHS CODE
	01 1A 125VAC	L LIGHT	00 	0 D.P.D.T.	
	P1 0.1A 60VDC	S STANDARD	01  L=17.5	3 S.P.D.T.	
	P2 0.1A 60VDC	H HEAVY	02  L=24.5		
	0.2A 60VDC		03  L=32		
	0.2A 125VAC		04  L=27.4		

#NOTE		
ITEM	RATING CURRENT	OPERATING FORCE
1	Code:01	S,H
2	Code:P1	L,S,H
3	Code:P2	L,S,H

OPERATING CHARACTERISTICS

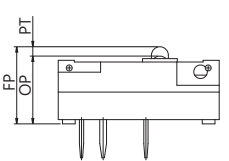
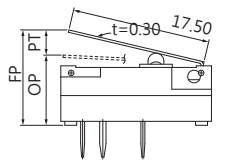
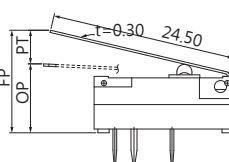
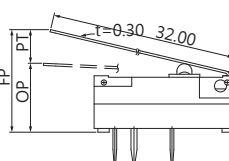
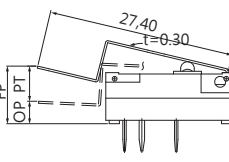
SWITCH TYPE	PART SUFFIX	OF - Max (gf)		OP Min. (mm)	PT Max. (mm)	OT Min. (mm)	RP Max. (mm)	RF - Min (gf)		
		2 Ways	1 Way					DPDT	SPDT	
HM2- □□□ -00 □ -Z		H	215	165	7.9	1.3	0.4	8.9	40	20
		S	155	135					25	14
		L	108	90					15	8
HM2- □□□ -01 □ -Z		H	73	55	8.5	3.6	1.1	11.6	10	7
		S	60	45					7	5
		L	40	30					4	3
HM2- □□□ -02 □ -Z		H	54	40	8.6	5.1	1.1	13.1	7	4
		S	42	32					5	3
		L	26	22					3	2
HM2- □□□ -03 □ -Z		H	40	31	8.8	6.7	1.1	14.6	5	3.5
		S	30	25					3	2.5
		L	20	17					2	1.5
HM2- □□□ -04 □ -Z		H	47	35	2.4	6.1	1.1	8.1	6	4
		S	36	28					4	3
		L	23	19					2	1.5